

moda

Be My Neighbor

Block 13

10½" x 18" finished

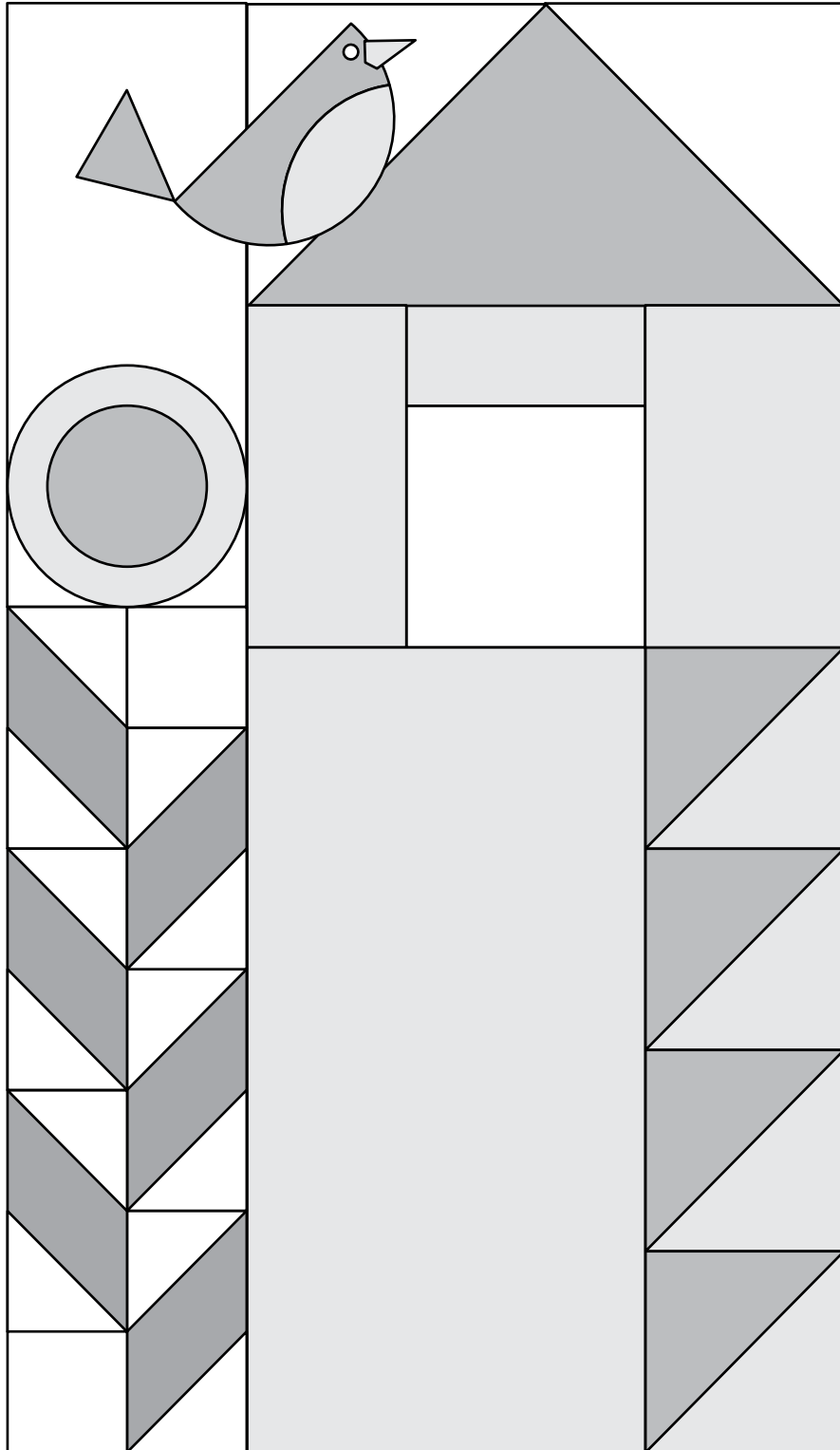

General Information

- These are very scrappy blocks. Mix your favorite Moda prints to create your colorful neighborhood!
- Share your progress and final quilt at #BeMyNeighbor. We would love to see your results!

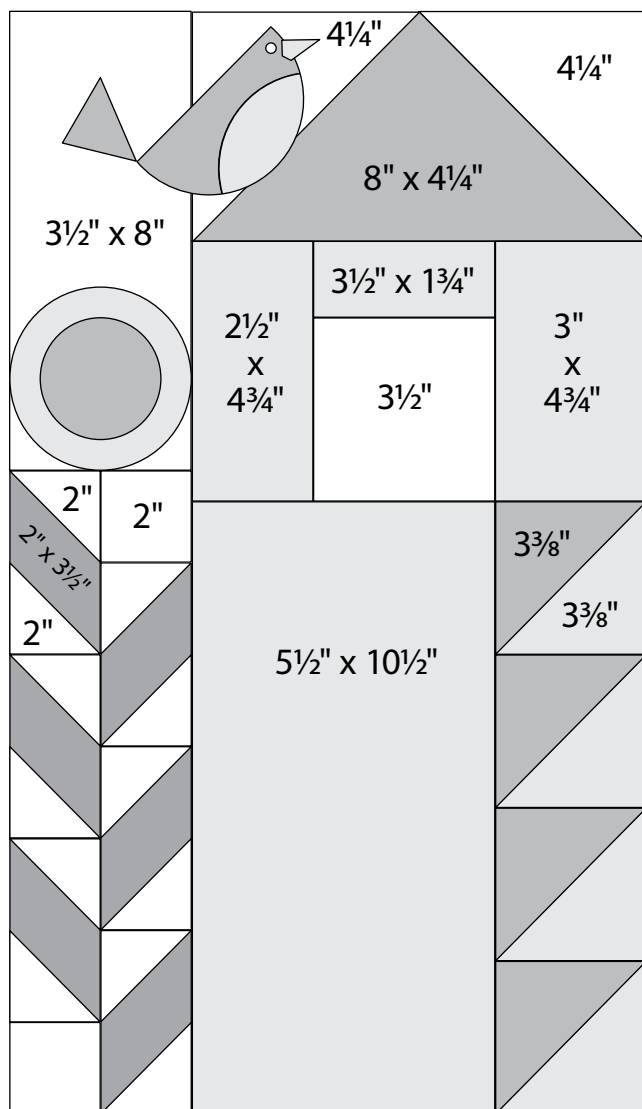

Block 13
11" x 18 1/2" unfinished

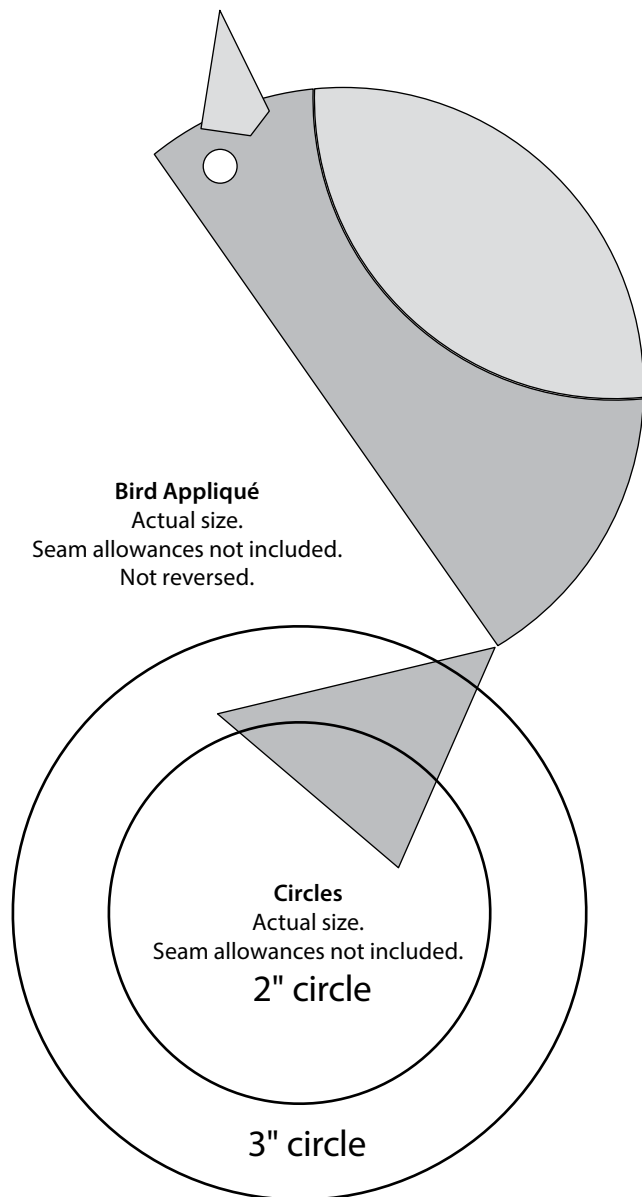

Cutting

Leaves

6–2" x 3 1/2" rectangles

Flowers

2 circles

Bird Appliqué

1–beak

1–body

1–tail

1–wing

1–eye

Roof

1–8" x 4 1/4" rectangle

Half-Square Triangles

2–3 3/8" squares; cut in half once
on the diagonal to make
4 half-square triangles (HST)

Window

1–3 1/2" square

House

1–5 1/2" x 10 1/2" rectangle

2–3 3/8" squares; cut in half once
on the diagonal to make
4 half-square triangles (HST)

1–3 1/2" x 1 3/4" rectangle

1–3" x 4 3/4" rectangle

1–2 1/2" x 4 3/4" rectangle

Background

2–4 1/4" squares

14–2" squares

1–3 1/2" x 8" rectangle



Be My Neighbor

Block 13 is 10½" x 18" finished.

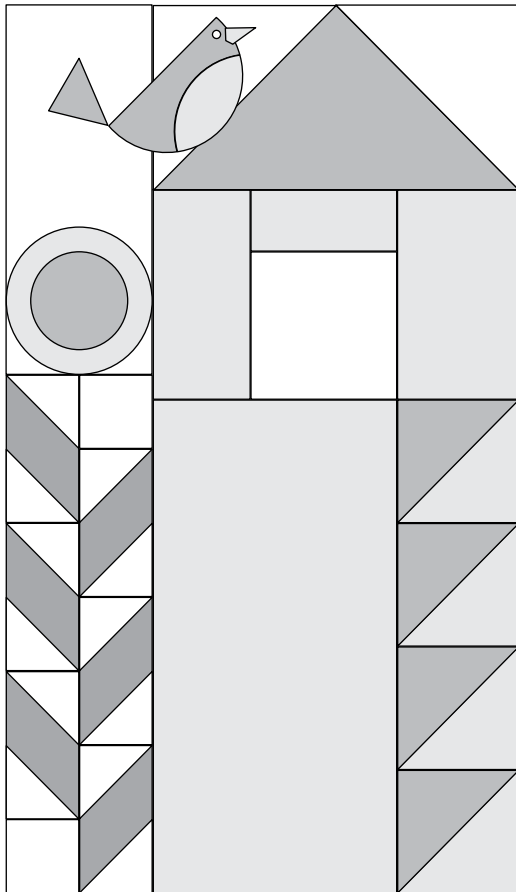

Construction

Use ¼" seams. Press in the direction of the arrows in the diagrams.

1 House Roof

Draw a diagonal line from corner to corner on the wrong side of 2–4¼" background squares. Layer a 4¼" marked background square, right sides together, on 1–8" x 4¼" roof rectangle as shown. Sew on the diagonal line. Trim ¼" from the sewn line. Press to reveal the triangle. Repeat on the the opposite end of the same rectangle. Make 1.

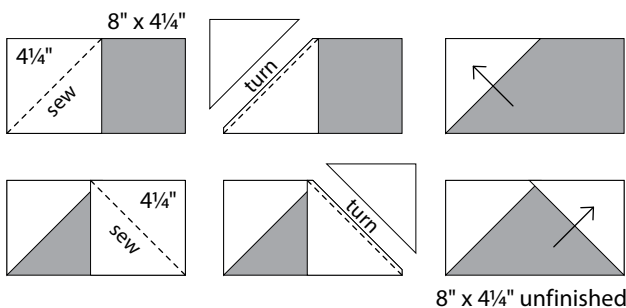

2 Flower

(A) Draw a diagonal line from corner to corner on the wrong side of 12–2" background squares. Layer a 2" marked background square, right sides together, on 1–2" x 3½" leaf rectangle as shown. Sew on the diagonal line. Trim ¼" from the sewn line. Press to reveal the triangle. Repeat on the the opposite end of the same rectangle. Make 3 leaf As and 3 leaf Bs.

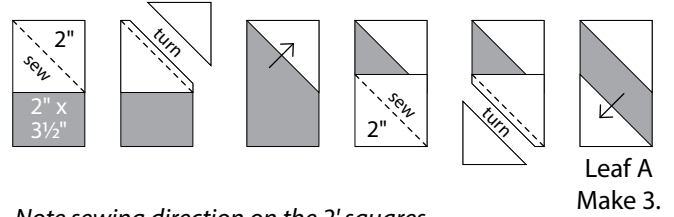

Note sewing direction on the 2" squares.

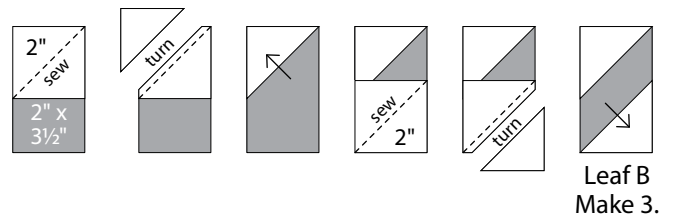

(B) Arrange and sew 3–Leaf As and 1–2" background square to make column A. Arrange sew 1–2" background square and sew 3–Leaf Bs to make column B. Join the columns, add a 3½" x 8" background rectangle. Use you appliqué method of choice to add the circles.

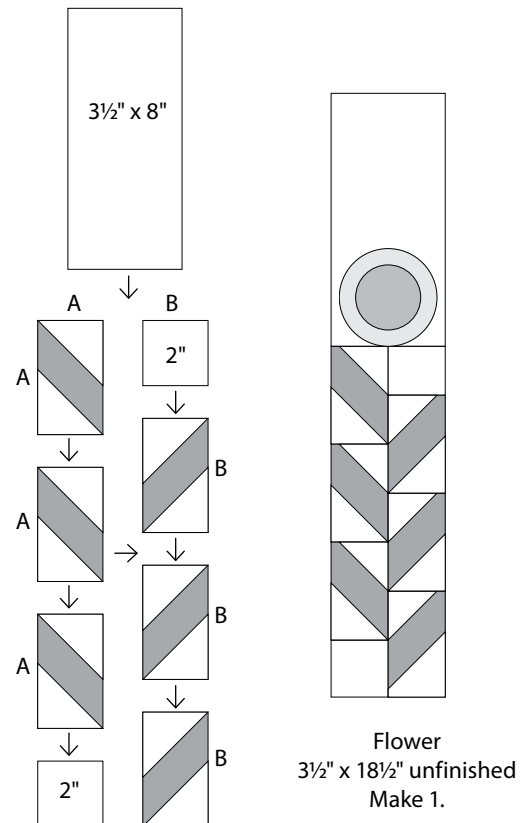

3 Join a $3\frac{3}{8}$ " dark HST and a $3\frac{3}{8}$ " house HST as shown. Make 4 half-triangle squares (HTS). Join the HTSs and a $5\frac{1}{2}$ " x $10\frac{1}{2}$ " house rectangle as shown.

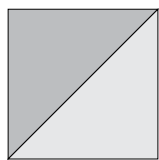
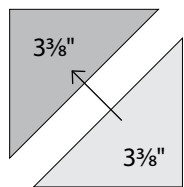

HTSs
3" x 3"
unfinished
Make 4.

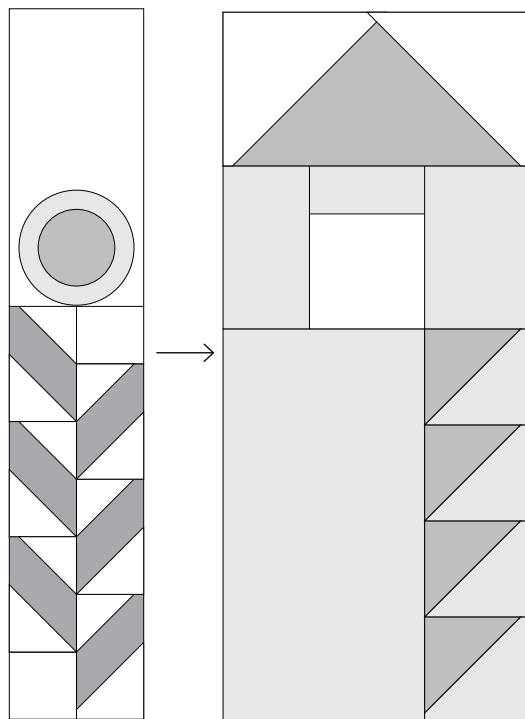
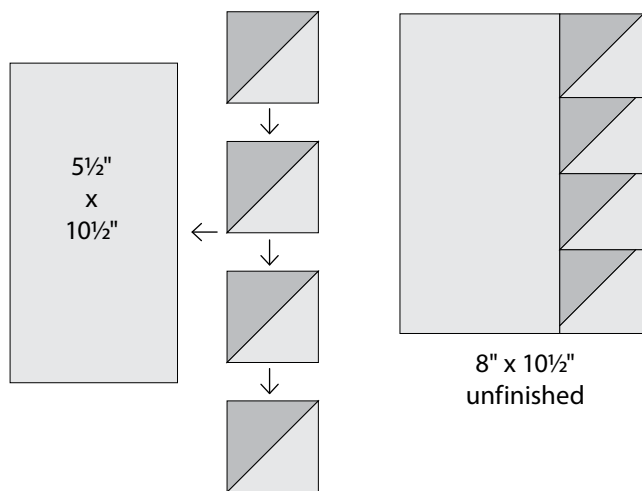

moda

4 Assemble the house as shown. Use fusible web and a zig zag or blanket stitch to add the bird to the completed house block.

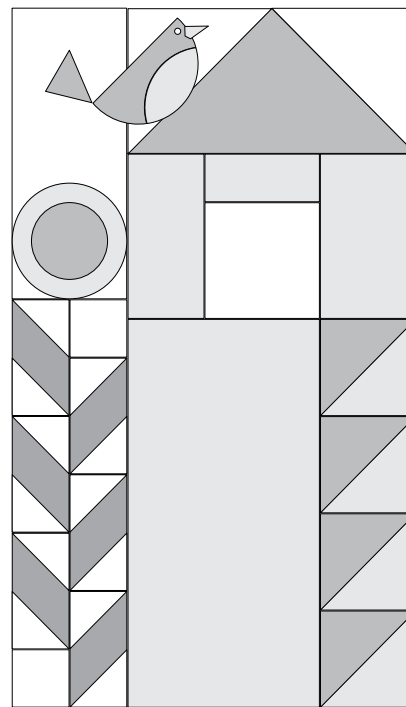
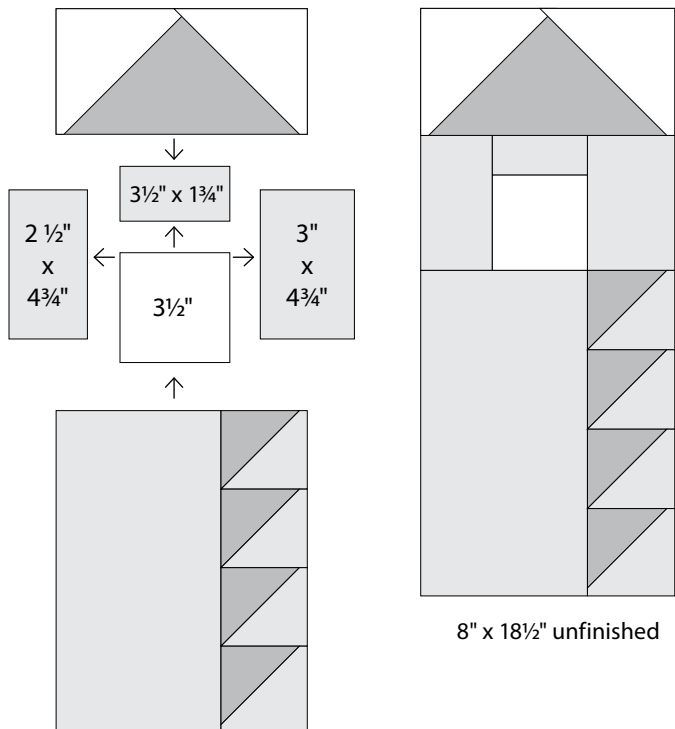

Block 13
11" x 18 1/2" unfinished